

# Gebrauchsanleitung Installation Instructions

GA-G005

14540C



**D-Reitersicherungssockel  
für 60mm  
Sammelschienensysteme**

**D Busbar-Mounting Fuse Bases  
for 60mm busbar systeme**



**Vor Beginn der Arbeiten Gerät  
spannungsfrei schalten.  
Inbetriebsetzung und Wartung  
nur durch Fachpersonal.  
To prevent electrical shock  
disconnect from power source  
before installing or servicing.  
Work and maintenance by  
skilled staff only.**

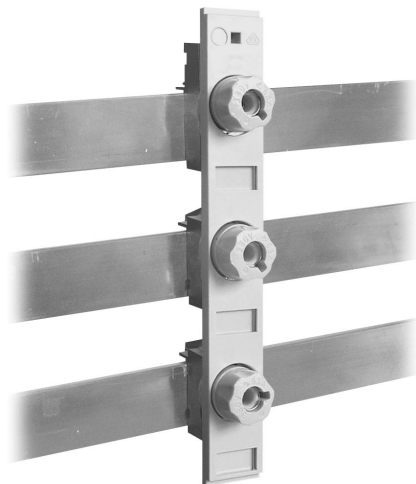

**Anschlußart "F25"  
Terminal type "F25"**

**Anzugsdrehmoment  
Tightening torque**

**Klemmbereich Kabel  
Clamping range**



Fahrstuhlklemme / Elevator terminal

2,6 Nm

1 - 25 mm<sup>2</sup> Cu



Technische Änderungen vorbehalten!  
Subject to technical alterations!

①

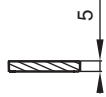
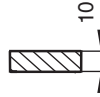
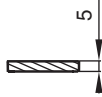
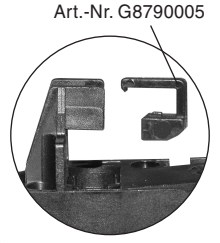
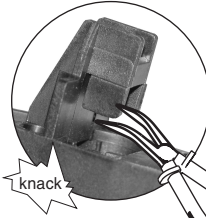
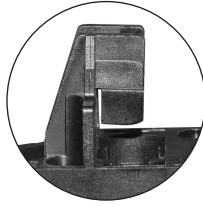

②

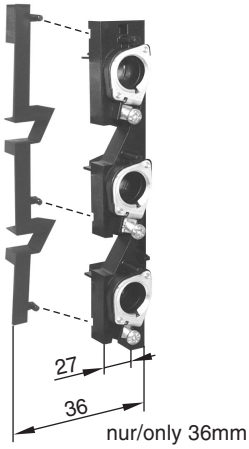

③

Montage / Assembly

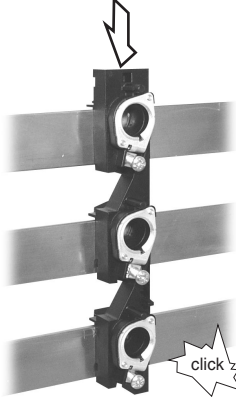

Demontage / Disassembly

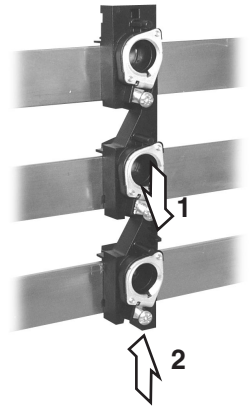

④

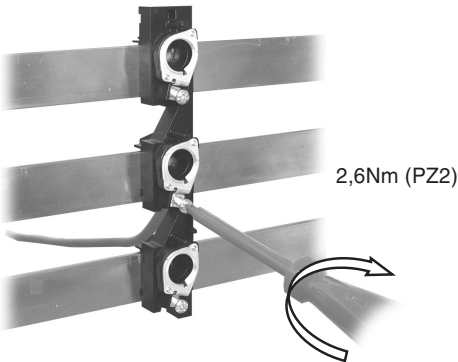

⑤

