

Free-standing cable distribution cabinets

Electrical parameters

Rated operational voltage Un	400V
Rated insulation voltage Ui	690V
Flamability category	V0
Degree of protection against external mechanical impacts	IK 10
Protection degree	IP44 (IP54)
Protection class	II
Operating temperature	-25°C ... 40°C

Dimensions

KVR 00

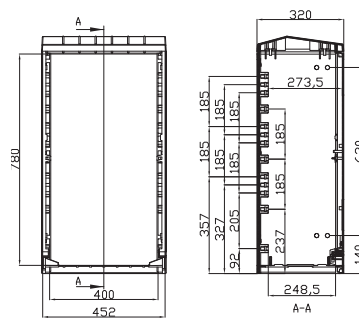

KVR 0

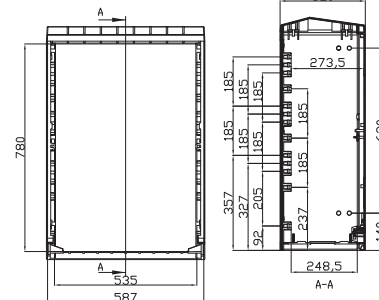

KVR 1

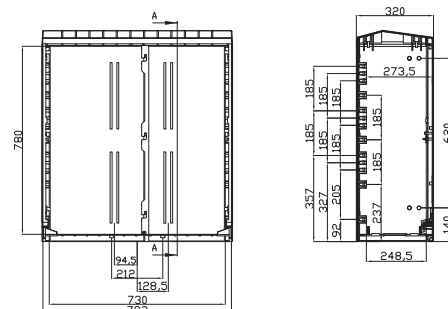
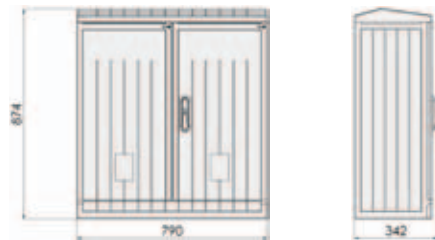

KVR 2

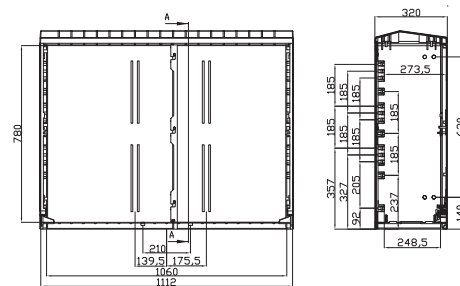
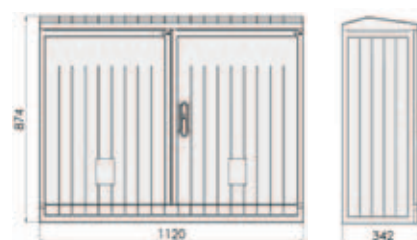

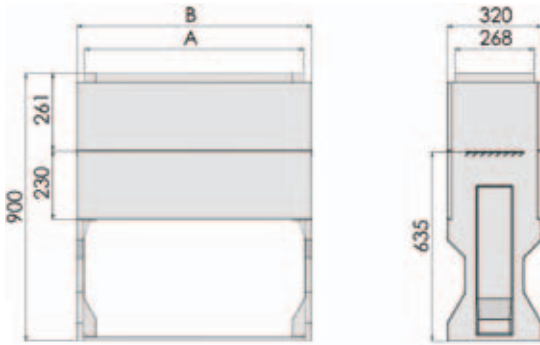

[mm]	A	B	C	D
KVR-P 00	460	408	360	332
KVR-P 0	595	543	495	467
KVR-P 1	790	738	690	662
KVR-P 2	1120	1068	1020	992

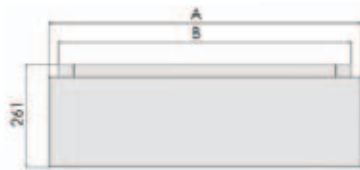
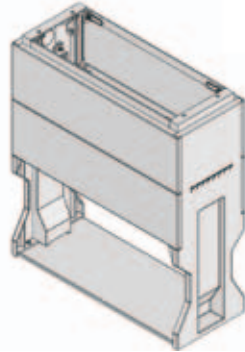
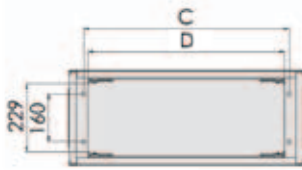

[mm]	A	B	C	D
KVR-PE 00	460	408	360	332
KVR-PE 0	595	543	495	467
KVR-PE 1	790	738	690	662
KVR-PE 2	1120	1068	1020	992

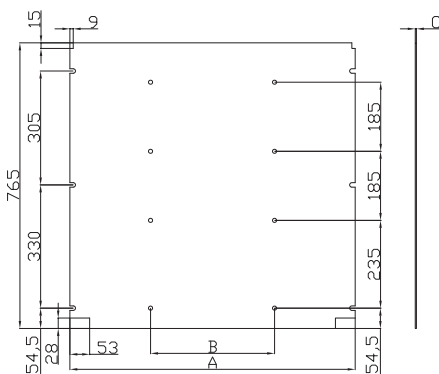
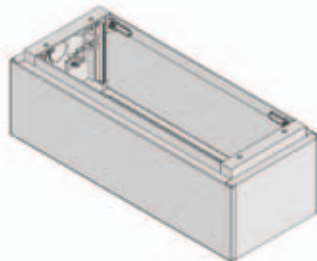
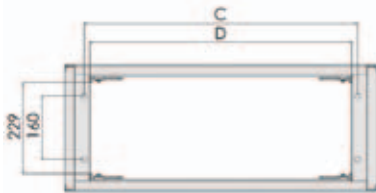

[mm]	A	B	C
KVR-MP 00	435	-	2
KVR-MP 0	572	-	2
KVR-MP 1	764	300	2
KVR-MP 2	1095	400	2

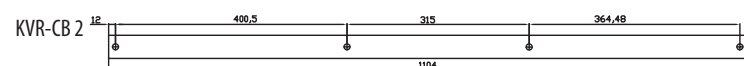
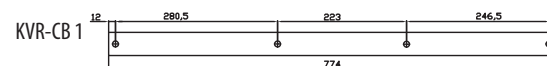
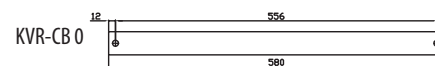
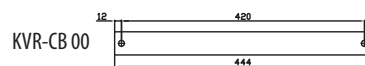

Technical data

[mm]	A
KVR-FB 00	450
KVR-FB 0	585
KVR-FB 1	784
KVR-FB 2	1110

Enclosure ventilation

